



**EASY  
INSTALL**



**CORDED  
CONTROL**

## FOREST CORDED Systems

Heavy duty corded curtain track systems with separate internal cord channels; preventing cord sag and eliminating cord tangle.

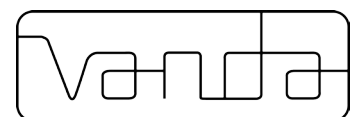

CKS® corded | Coded Klick System  
CCS® corded | Coded Contract System

THE WORLD  
BEHIND  
YOUR  
CURTAINS

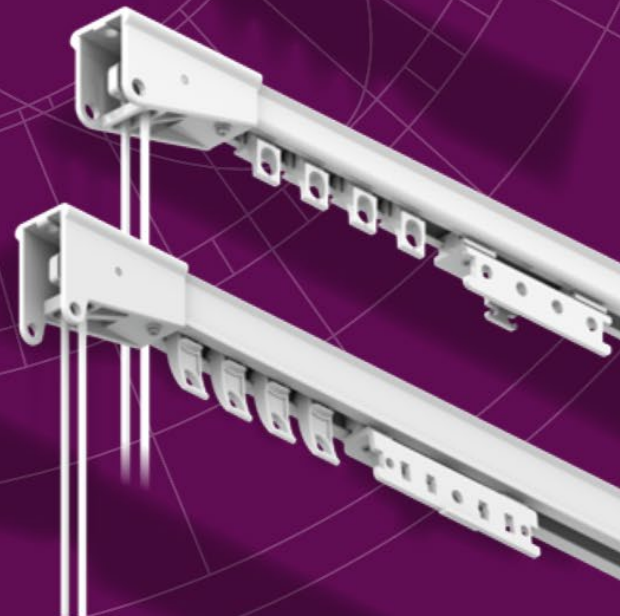



## PRODUCT INFORMATION

- Heavy duty cord operated system, with separate internal cord channels; preventing cord sag and eliminating cord tangle.
- Quick installation with "Smart Klick". Brackets for wall and ceiling applications.
- Heavy duty clickable carriers - UV protected.
- Can be used with standard carriers or Vanda Wave Heading
- Maximum fabric weight: 8 kg. per mtr
- Colours available: white & silver
- Track finish: chromated powder coating with a factory applied patented dry lubricant.
- Available in 6 meter lengths

## PROFILE

- Shown actual size 1:1
- Aluminium Extrusion
- Weight: 300 gram per meter
- Dimensions: 20 mm x 20 mm

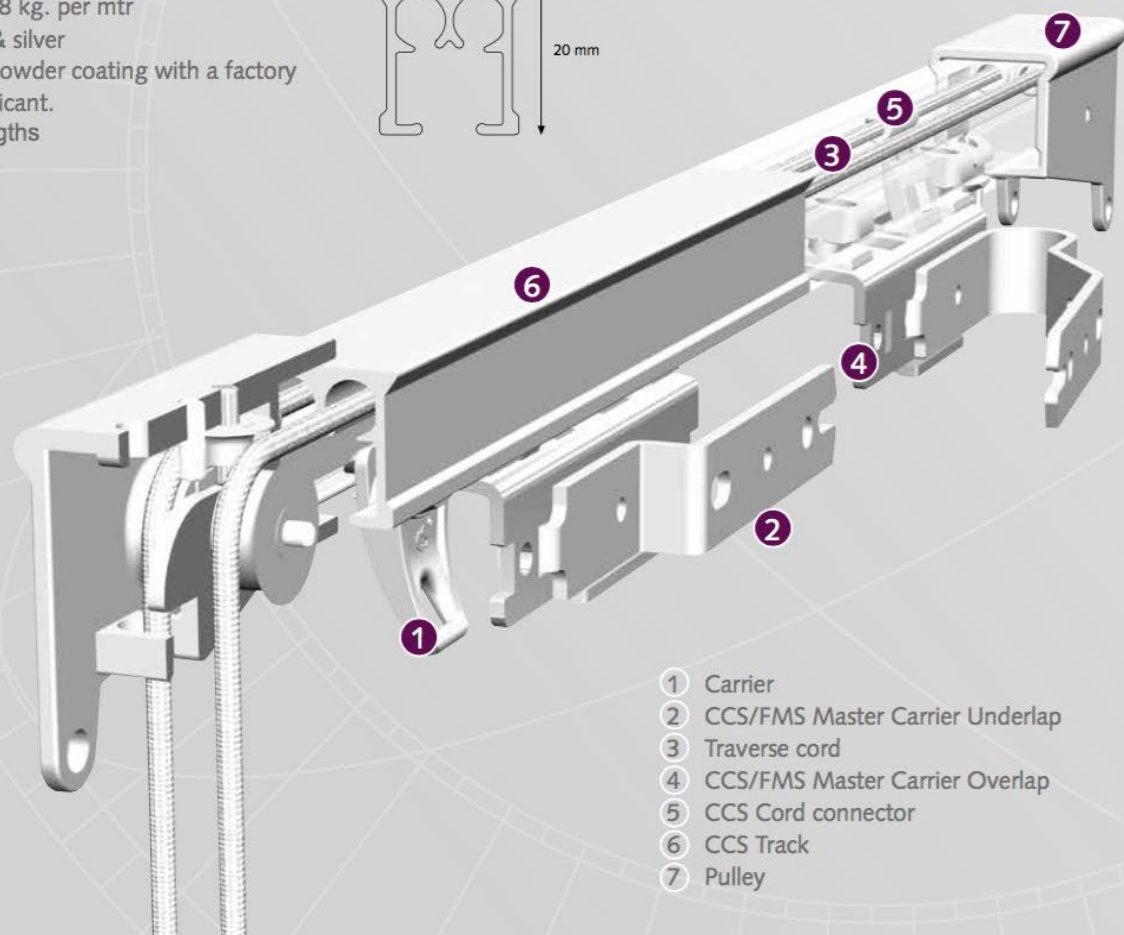
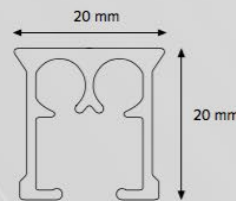

Easy installation  
click - position - tighten



Clickable carrier

38 mm

- 1 Carrier
- 2 CCS/FMS Master Carrier Underlap
- 3 Traverse cord
- 4 CCS/FMS Master Carrier Overlap
- 5 CCS Cord connector
- 6 CCS Track
- 7 Pulley





## MOUNTING BRACKETS

### Wall bracket

3.5 cm  
6 cm

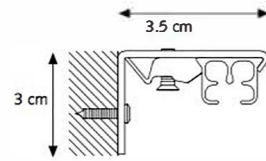

### Spring Clip Ceiling Bracket with concealed cover

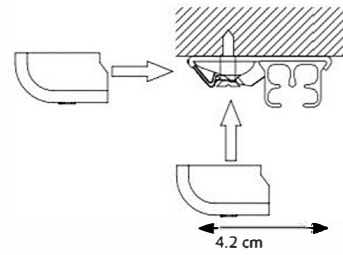

### Smart Click Ceiling Bracket



## APPLICATIONS



### SK Aluminium Wall Bracket single

A) 7.5 cm      B) 6.3 cm

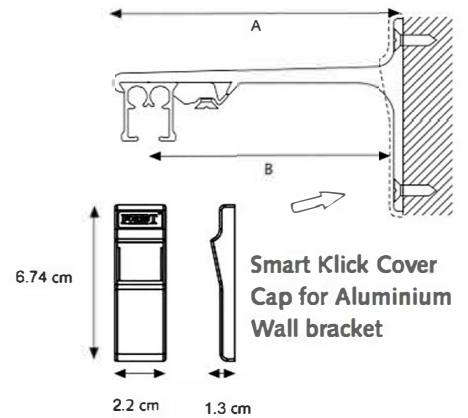

### SK Wall bracket aluminium double

A) 15 cm      B) 9.2 cm      C) 4.5 cm

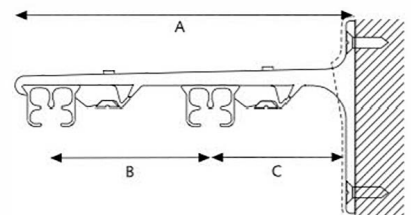

## FOR USE IN

Hotels - motels - offices - healthcare - schools - residential or any location where a heavy duty cord traverse system is required.

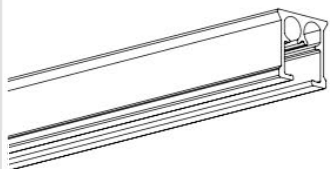

**CCS TRACK**  
Aluminium extrusion, powder coated, lubricated.



**CS / CCS AS CARRIER**  
"Clickable", offset, constructed of UV-resistant plastic. 10 Carriers on a break-away strip. Can be clicked in after



**CS STOPCARRIER**  
Clickable.



**SMART CLICK TOP FIX BRACKET**  
Slides onto the track, powder coated. Regular duty.



**SPRING CLIP TOP FIX BRACKET**  
"Klicks" onto track, powder coated.

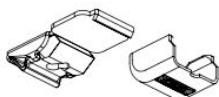

**SPRING CLIP TOP FIX BRACKET WITH COVER PLATE**



**SMART CLICK WALL BRACKET (3.5)**  
"Klicks" onto track, powder coated.  
One screw attachment. For light weight use only.



**ADJUSTABLE WALL BRACKET SINGLE**  
For light weight use only

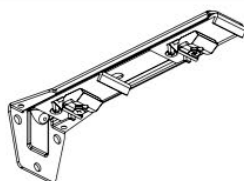

**ADJUSTABLE WALL BRACKET DOUBLE**  
For light weight use only



**SLIMLINE SINGLE WALL BRACKET**

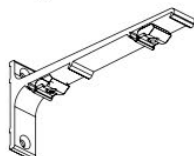

**SLIMLINE DOUBLE WALL BRACKET**



**COVERPLATE FOR  
WALL BRACKET**

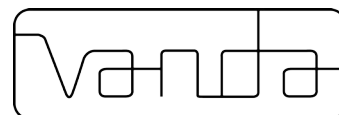

0800 826 326  
Enquiries@vanda.co.nz